



Digital Night Vision Riflescopes

SIGHTLINE

RETICLE CATALOGUE



SIGHTLINE
N450 / N455

SIGHTLINE
N470 / N475



Non-scalable reticles

D50i
X54i
M58i

Scalable reticles

X51Fi-300
M56Fi
M57Fi

Non-scalable reticles

D50i
X54i
M58i

Scalable reticles

X51Fi-300
M56Fi
M57Fi

RETICLE CATALOGUE



Digital NV Riflescopes

SIGHTLINE

N450 / N455



Reticle

D50i

Reticle parameters (for 4x magnification)

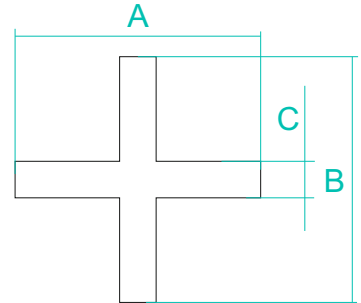

	MOA	cm @ 100 m
Section A	2.6	7.4
Section B	2.6	7.4
Section C	0.4	1.1



Digital NV Riflescopes

SIGHTLINE

N450 / N455

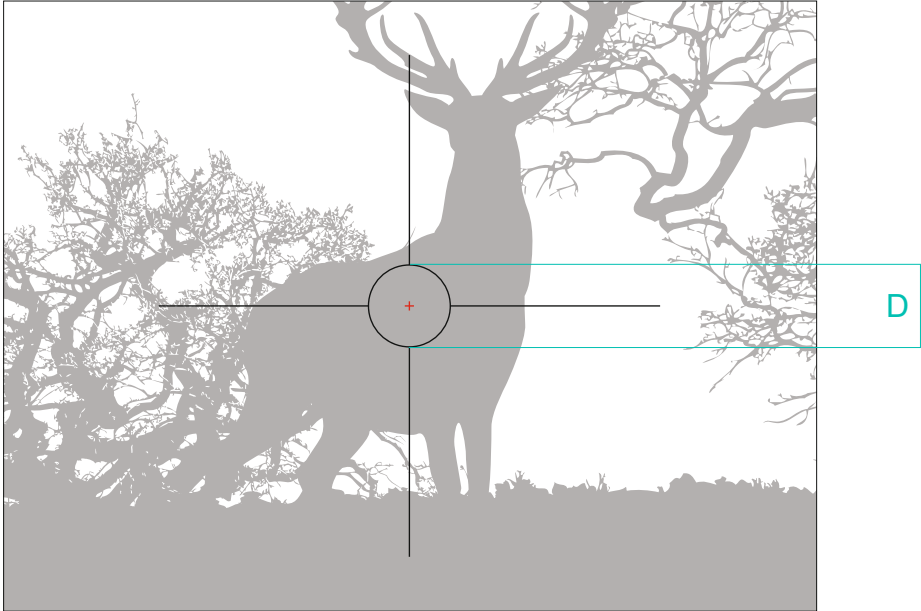

Reticle

X54i

Reticle parameters (for 4x magnification)

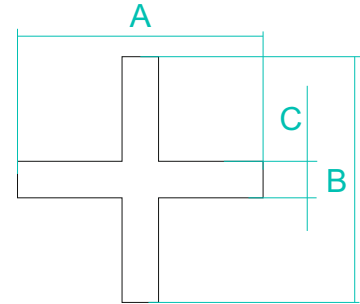

	MOA	cm @ 100 m
Section A	2.6	7.4
Section B	2.6	7.4
Section C	0.4	1.1
Section D	34.4	100



Digital NV Riflescopes

SIGHTLINE

N450 / N455

Reticle

M58i

Reticle parameters

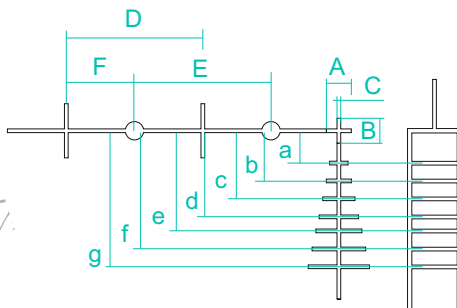
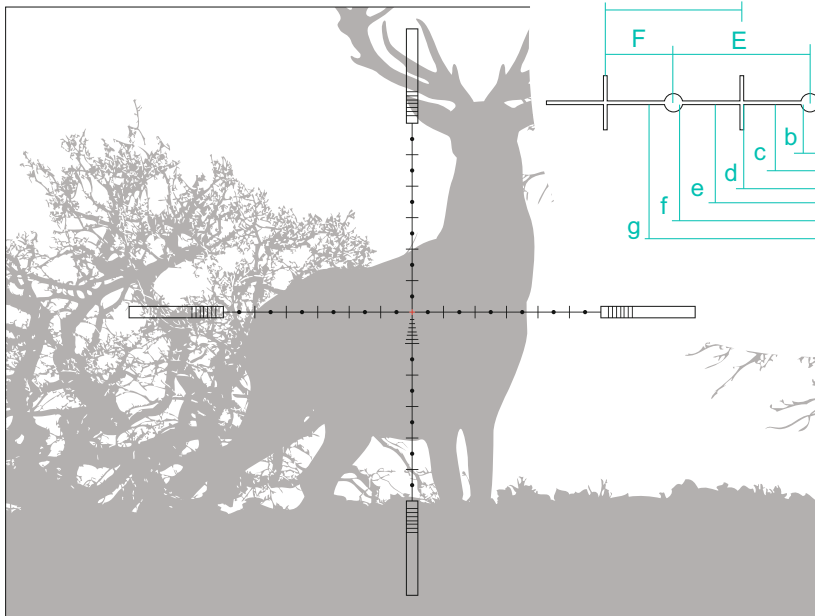

	MOA	cm @ 100 m
Section A	2.6	7.4 on 4x
Section B	2.6	7.4 on 4x
Section C	0.4	1.1 on 4x
Section D	3.5	10 (1 mil) on 16x
Section E	3.5	10 (1 mil) on 16x
Section F	3.5	10 (1 mil) on 8x

- Section a:** 1 mil (10 cm @ 100 m) on 4x
- Section b:** 1 mil (10 cm @ 100 m) on 6x
- Section c:** 1 mil (10 cm @ 100 m) on 8x
- Section d:** 1 mil (10 cm @ 100 m) on 10x
- Section e:** 1 mil (10 cm @ 100 m) on 12x
- Section f:** 1 mil (10 cm @ 100 m) on 14x
- Section g:** 1 mil (10 cm @ 100 m) on 16x



Digital NV Riflescopes

SIGHTLINE

N450 / N455

Reticle

X51 FI-300

Reticle parameters (apply to all magnifications)

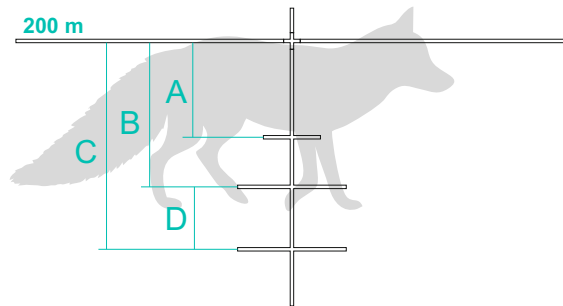
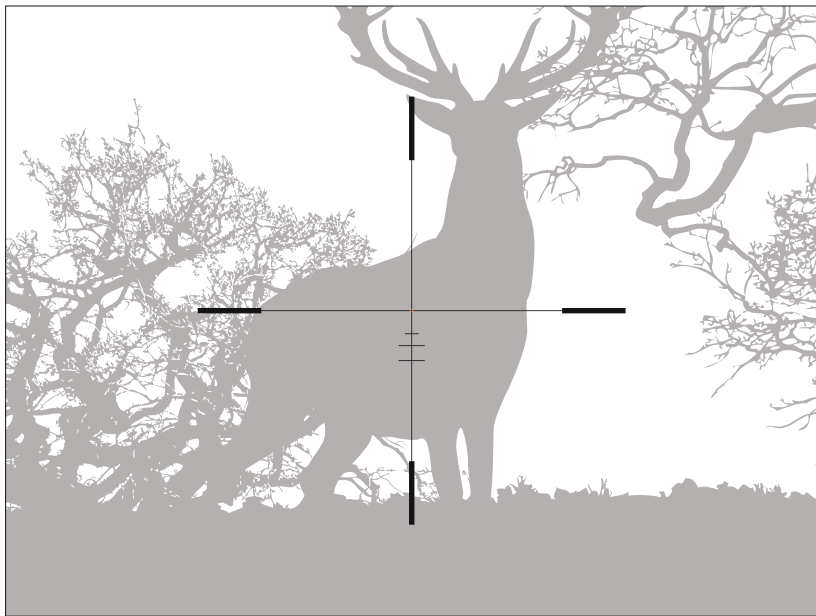

	200 m	300 m
Section A	15 cm (fox body)	23 cm (roe deer body)
Section B	23 cm (roe deer body)	35 cm (wild boar body)
Section C	35 cm (wild boar body)	50 cm (deer body)
Section D	—	15 cm (fox body)



Digital NV Riflescopes

SIGHTLINE

N450 / N455

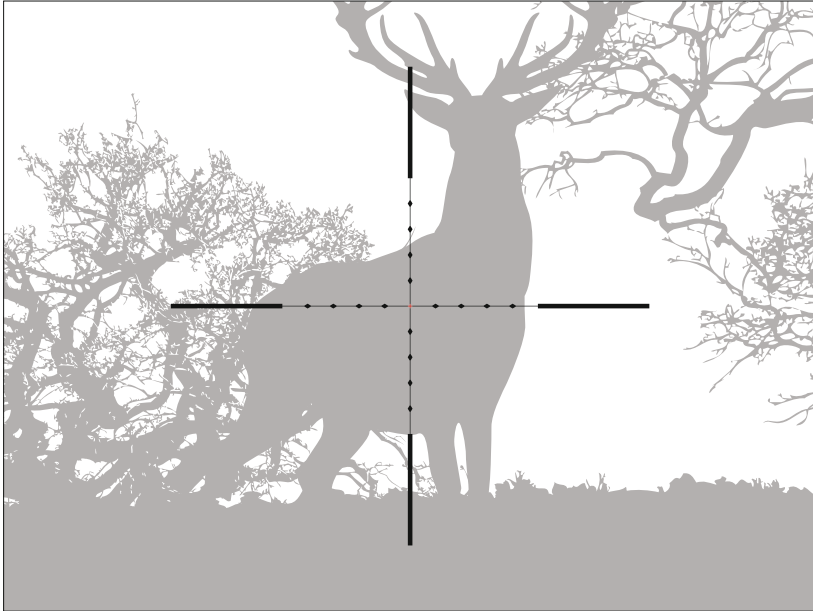

Reticle

M56Fi

Reticle parameters (apply to all magnifications)

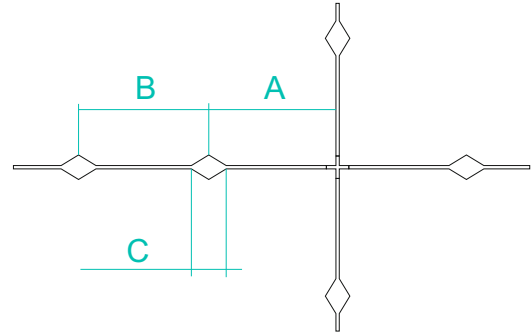

	MOA	cm @ 100 m
Section A	3.5	10 (1 mil)
Section B	3.5	10 (1 mil)
Section C	0.86	2.5 (0.25 mil)



Digital NV Riflescopes

SIGHTLINE

N450 / N455

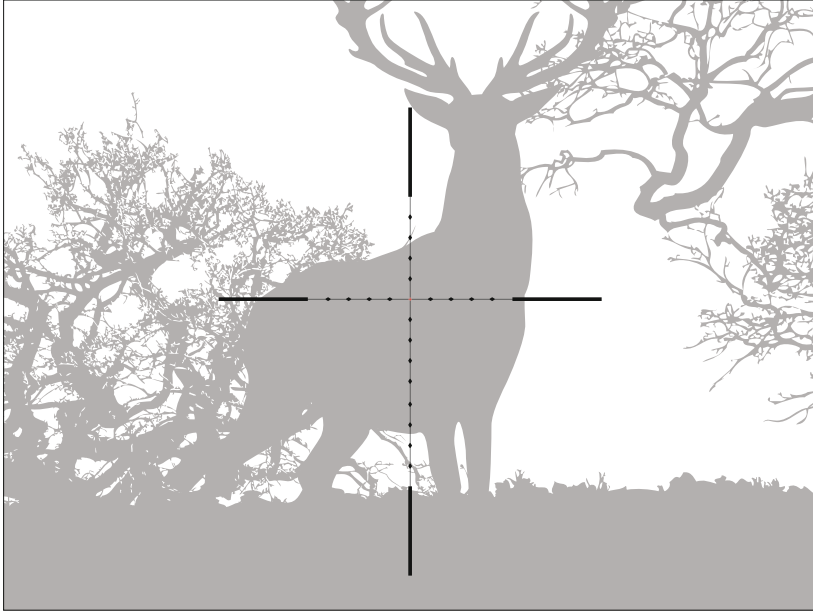

Reticle

M57Fi

Reticle parameters (apply to all magnifications)

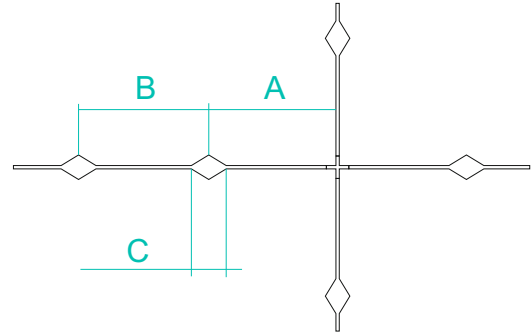

	MOA	cm @ 100 m
Section A	3.5	10 (1 mil)
Section B	3.5	10 (1 mil)
Section C	0.86	2.5 (0.25 mil)



Digital NV Riflescopes

SIGHTLINE

N470 / N475



Reticle

D50i

Reticle parameters (for 6x magnification)

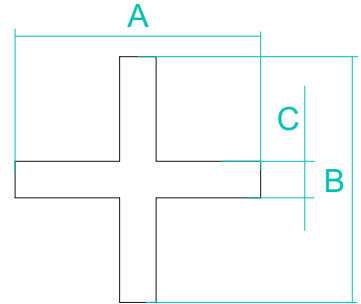

	MOA	cm @ 100 m
Section A	1.8	5.3
Section B	1.8	5.3
Section C	0.3	0.8



Digital NV Riflescopes

SIGHTLINE

N470 / N475

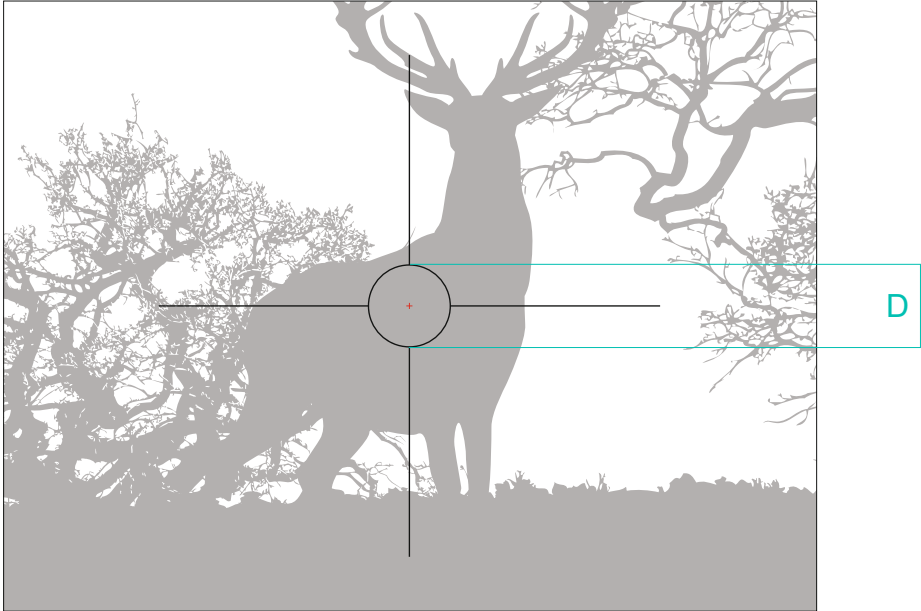

Reticle

X54i

Reticle parameters (for 6x magnification)

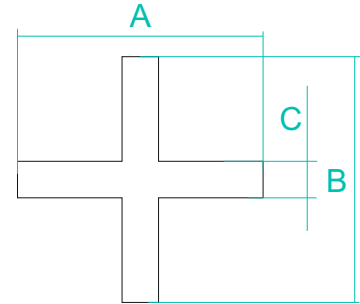

	MOA	cm @ 100 m
Section A	1.8	5.3
Section B	1.8	5.3
Section C	0.3	0.8
Section D	34.4	100



Digital NV Riflescopes

SIGHTLINE

N470 / N475

Reticle

M58i

Reticle parameters

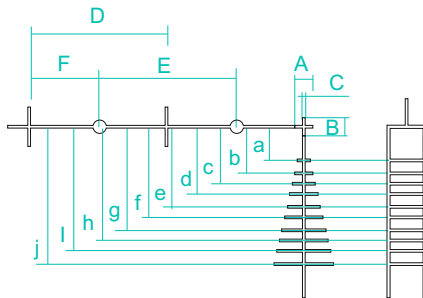
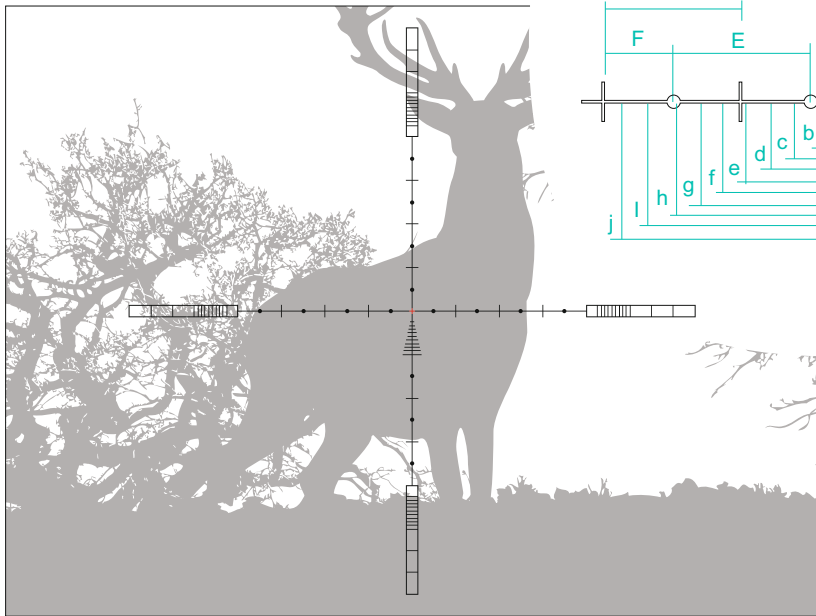

	MOA	cm @ 100 m
Section A	1.8	5.3 on 6x
Section B	1.8	5.3 on 6x
Section C	0.3	0.8 on 6x
Section D	3.5	10 (1 mil) on 24x
Section E	3.5	10 (1 mil) on 24x
Section F	3.5	10 (1 mil) on 12x

- Section a:** 1 mil (10 cm @ 100 m) on 6x
- Section b:** 1 mil (10 cm @ 100 m) on 8x
- Section c:** 1 mil (10 cm @ 100 m) on 10x
- Section d:** 1 mil (10 cm @ 100 m) on 12x
- Section e:** 1 mil (10 cm @ 100 m) on 14x
- Section f:** 1 mil (10 cm @ 100 m) on 16x
- Section g:** 1 mil (10 cm @ 100 m) on 18x
- Section h:** 1 mil (10 cm @ 100 m) on 20x
- Section i:** 1 mil (10 cm @ 100 m) on 22x
- Section j:** 1 mil (10 cm @ 100 m) on 24x



Digital NV Riflescopes

SIGHTLINE

N470 / N475

Reticle

X51 FI-300

Reticle parameters (apply to all magnifications)

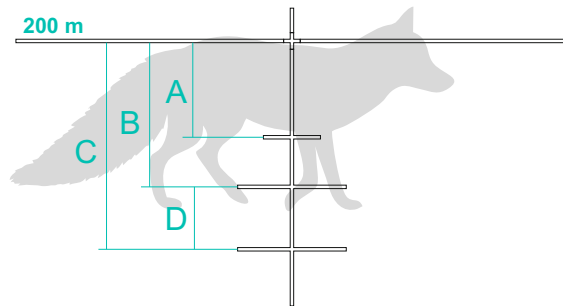
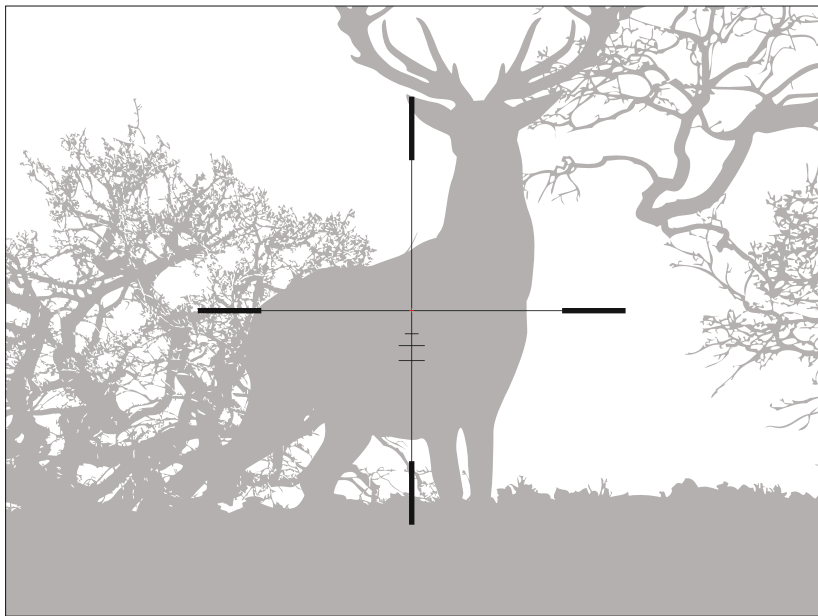

	200 m	300 m
Section A	15 cm (fox body)	23 cm (roe deer body)
Section B	23 cm (roe deer body)	35 cm (wild boar body)
Section C	35 cm (wild boar body)	50 cm (deer body)
Section D	—	15 cm (fox body)



Digital NV Riflescopes

SIGHTLINE

N470 / N475

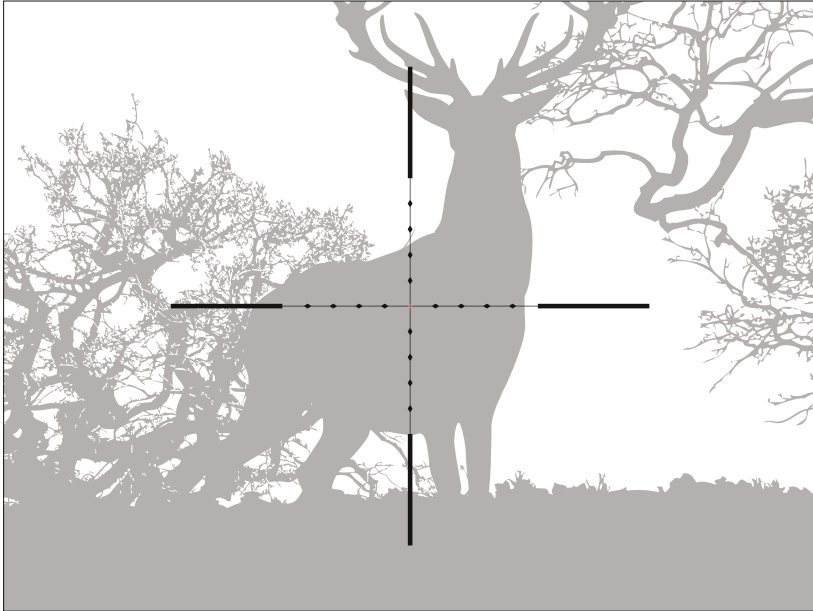

Reticle

M56Fi

Reticle parameters (apply to all magnifications)

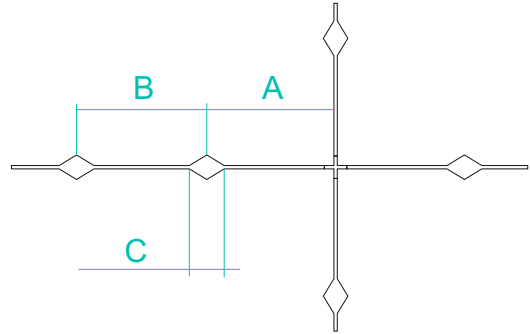

	MOA	cm @ 100 m
Section A	3.5	10 (1 mil)
Section B	3.5	10 (1 mil)
Section C	0.86	2.5 (0.25 mil)



Digital NV Riflescopes

SIGHTLINE

N470 / N475

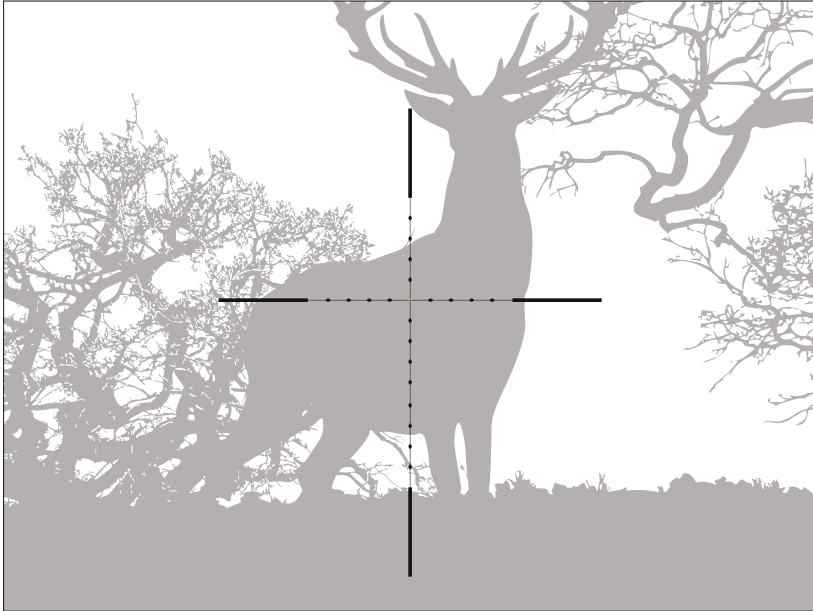

Reticle

M57Fi

Reticle parameters (apply to all magnifications)

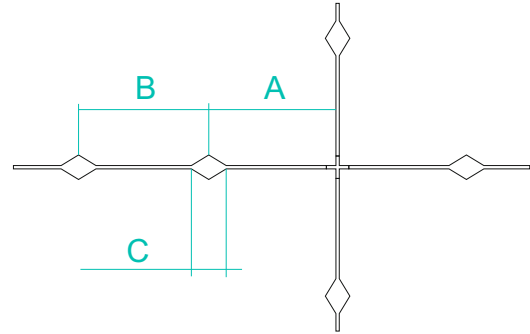

	MOA	cm @ 100 m
Section A	3.5	10 (1 mil)
Section B	3.5	10 (1 mil)
Section C	0.86	2.5 (0.25 mil)



SIGHTLINE RETICLE
CATALOGUE



Facebook
@YukonAdvancedOptics
Worldwide



Youtube
Yukon Advanced Optics
Worldwide



Instagram
@yukon.advanced.optics